

CNR GAS DISCHARGE TUBE

The functions of Gas-Discharge components are effected by many parameters; such as gas type, pressure of gas and humidity etc. especially, the pollution (particles) leads an abnormal reaction. We take a proven technique to make sure the working condition is "close and isolated" - hermetic sealing of discharge space.

CNR (CeNtRa Science Co.,) produce two kinds of GDT component:

1ST type: Cut-Ditch type - (CSP series: Spark-gap); fig 1-1

2ND type: Gap type (CG series: GDT); fig 1-2

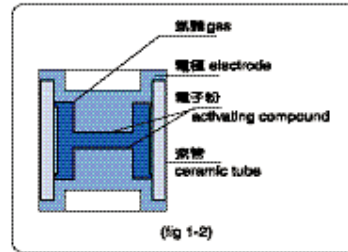
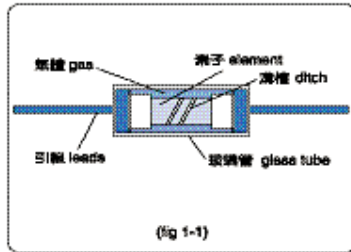

CNR-CSP series: UL-497B (Protector for data communication and fire alarm circuit)

E220380: Section 2

CNR-CG series: UL-497B (Protector for data communication and fire alarm circuit)

E220380: Section 1

Protection principle of CNR-GDT component:

Generally, GDT components work whenever a surge (voltage) exceed the rated-working-voltage of GDT. As the arc with high current (because of low impedance of GDT) is ignited, GDT can prevent a further rise of surge voltage.(approximately some 10 volts)

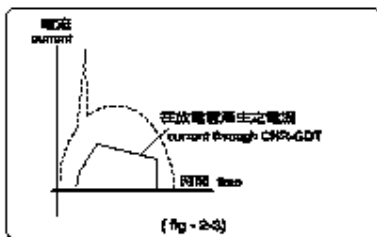
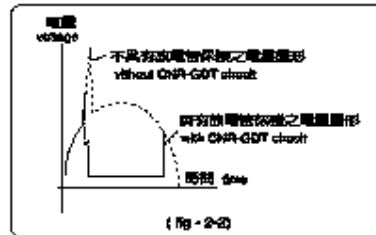
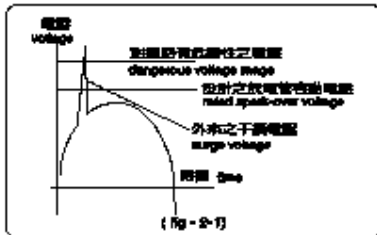

Operating mode of CNR-GDT

A simplified CNR-GDT could be compared with a symmetrical switch (with very low capacitance) whose resistance may change from several G-ohms (normal operation) to <1 ohm (ignited by surge voltage). CNR-GDT will automatically re t u rn to its original state (high impedance) as the surge has subsided .

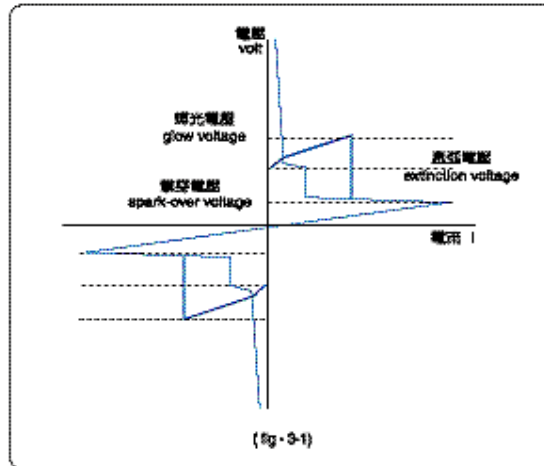

CNR-GDT CSP series

CNR-CSP series: UL-497B (Protector for data communication and fire alarm circuit)
E220380: Section 2

Features

- Quick response
- Low capacitance
- Good withstanding ability to surge
- Symmetry in both direction

Applications

- CRT cathode ray tube (fig 4-6)
- Mono - chrome monitor (fig 4-7)

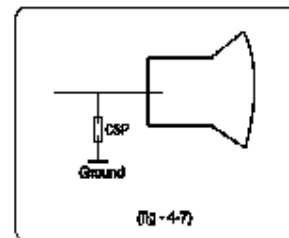
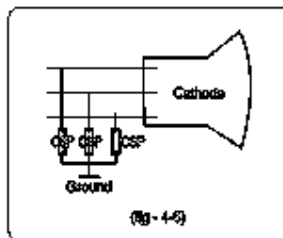

- Car radio/Radio cassette/ wireless equipment

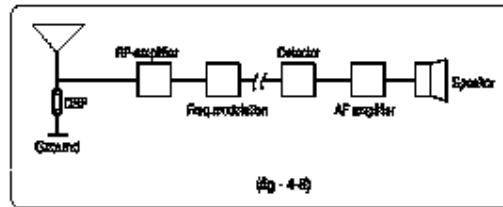

- Satellite broadcast and TV equipment

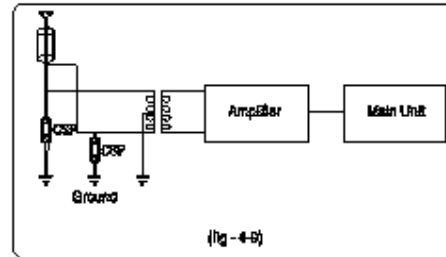

CNR GDT

CNR-CG series: UL-497B (Protector for data communication and fire alarm circuit)
E220380: Section 1

Features

- Quick response
- Low capacitance
- Good withstanding ability to surge
- Symmetry in both direction

Applications

- Limitation of a Sinusoidal overvoltage by CNR GDT (with CNR Varistors)

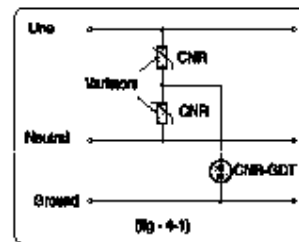

- Telephon/Fax machine/ Modem Protection

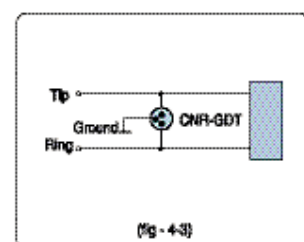
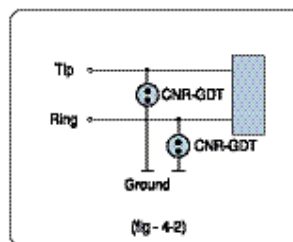

- Signal Line protection

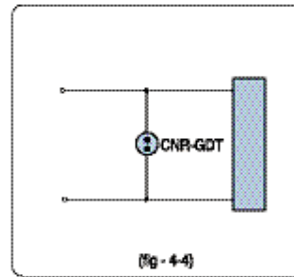

- CATV/Coax Line Protection

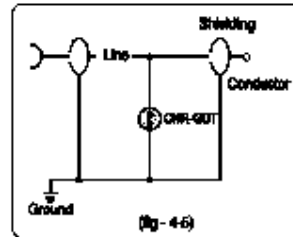

CSP SERIES



Designation System

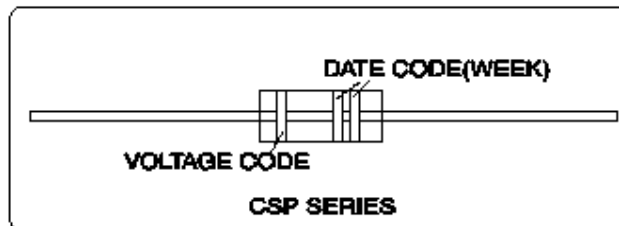

Series	CSP	CNR CSP SERIES	CSP
Norminal DC Spark-over Voltage	201	RED	201
	301	ORINGE	301
	401	YELLOW	401
VOLTAGE CODE	501	GREEN	501
	601	BLUE	601
	M	M: ±20%	M or
Norminal DC Spark-over Voltage TOLERANCE	N	N: ±30%	N
	T	TAPING	T or
TAPING FORM	B	BULK	B
TAPING SIZE			52

Designation System

CSP	201	M	T	52
				TAPING SIZE
			TAPING TYPE	
		TOLERANCE		
	DC spark-over voltage CSP			
SERIES				

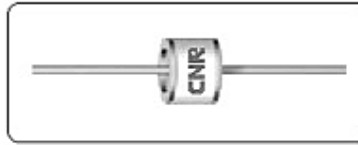
2-electrode CNR GDT

Designation System

Logo(Company)	C	(CeNtRa Science Co.,)	C
Ceramic Diameter	5	ϕ 5.5mm	5
	6	ϕ 6.3mm	6
	7	ϕ 7.0mm	7
	8	ϕ 8.0mm	8
Series	G	(Gas discharge tube)	G
Norminal DC Spark-over Voltage	(60V,75V,90V,150V...etc.)		XXX
lead's shape	" E" or " T" or " Y"		X
L/W	(BLANK)	without leads with leads	L
	L		

Designation System

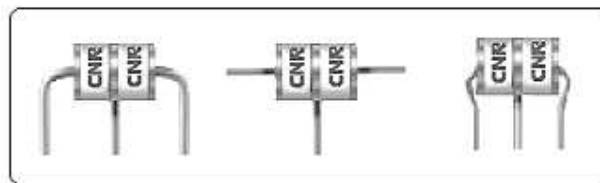
C	8	G	90	L
				with lead
			DC spark-over voltage	
		GDT series		
	DIAMETER			
CNR LOGO				

3-electrode CNR GDT

Designation System

Logo(Company)	C	(CeNtRa Science Co.,)	C
3-electrode CNR GDT	3L	3-electrode CNR GDT	3L
Series	G	(Gas discharge tube)	G
Norminal DC Spark-over Voltage	(60V,75V,90V,150V...etc.)		XXX
lead's shape	"E" or "T" or "Y"		X

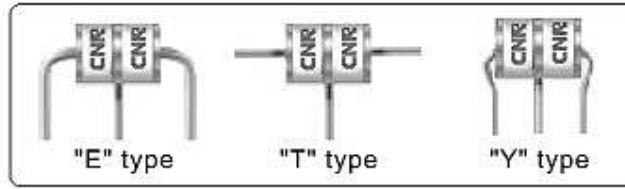

CNR GAS DISCHARGE TUBE



C	3L	G	90	Y
				lead's lead
			DC spark-over voltage	
		GDT series		
	3-electrode CNR GDT			
CNR LOGO				

CSP – SERIES (2.6mm)

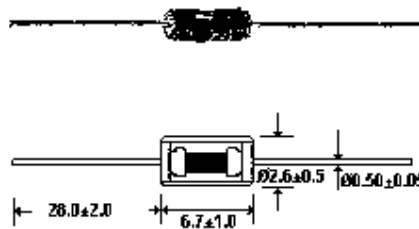

CNR	DC SPARK-OVER VOLT.			INSULATION RESISTANCE		CAPACITANCE		SURGE LIFE TEST	
	Min	Typical	Max	ohm	@ Vdc	Max	@ V	times	Interval(sec)
CSP	Vs(V)			Ri(Ω)		C(pF)		1500pF-10KV-0ohm	
P/N	100V/sec			Min	@	1KHz	@	1500pF-10KV-0ohm	
	Min	Typical	Max	ohm	Vdc	Max	V	times	Interval(sec)
CSP201M	160	200	240	100M	100	1	6	200	10
CSP301M	240	300	360	100M	100	1	6	200	10
CSP401M	320	400	480	100M	100	1	6	200	10
CSP501M	400	500	600	100M	100	1	6	200	10
CSP601M	480	600	720	100M	100	1	6	200	10

CNR - CSP series : U L - 497B (Protector for data communication and fire alarm circuit)
E220380 : Section 2

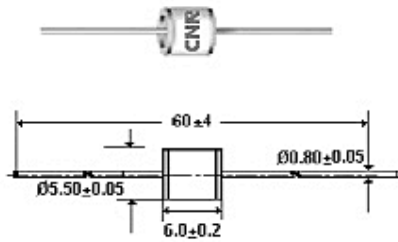
C5G-SERIES (5.5mm)

CNR	DC SPARK-OVER VOLT			IMPULSE SPARK-OVER	NOM. IMPULSE DISCHARGE CURRENT(S)	NOM. IMPULSE DISCHARGE CURRENT(L)	NOM. DISCHARGE CURRENT	INSULATION RESISTANCE		CAPCITANCE
	Vs(V)			Vis(V)				Ri(Ω)		C(pF)
P/N	100V/sec			1kV/usec	8x20usec	10*1000usec	1sec;50Hz	Min(log)	@	1KHz
	Min	Typical	Max	Max	kA	A	A	ohm	V	Max
C5G75	60	75	90	700	2.5	50	2.5	9	25	2
C5G90	72	90	108	700	2.5	50	2.5	9	50	2
C5G150	120	150	180	700	2.5	50	2.5	9	50	2
C5G230	184	230	276	800	2.5	50	2.5	9	100	2
C5G300	240	300	360	800	2.5	50	2.5	9	100	2
C5G350	280	350	420	800	2.5	50	2.5	9	100	2
C5G470	376	470	564	900	2.5	50	2.5	9	250	2
C5G600	480	600	720	1200	2.5	50	2.5	9	250	2
C5G1000	800	1000	1200	1600	2.5	50	2.5	10	250	2

CNR - CG series : UL - 497B (Protector for data communication and fire alarm circuit)
 E 220380 : Section 1

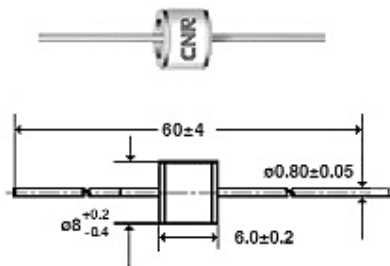
C8G-SERIES (8.0mm)

CNR	DC SPARK-OVER VOLT			IMPULSE SPARK-OVER	NOM. IMPULSE DISCHARGE CURRENT(S)	NOM. IMPULSE DISCHARGE CURRENT(L)	NOM. DISCHARGE CURRENT	INSULATION RESISTANCE		CAPCITANCE
	Min	Typical	Max					Ri(Ω)	@	
	Vs(V)			Vis(V)				Ri(Ω)		C(pF)
P/N	100V/sec			1kV/usec	8x20usec	10*1000usec	1sec;50Hz	Min(log)	@	1KHz
	Min	Typical	Max	Max	kA	A	A	ohm	V	Max
C8G60	48	60	72	600	5	50	5	9	20	2
C8G75	60	75	90	600	10	100	10	10	25	1
C8G90	72	90	108	700	10	100	10	10	50	1
C8G110	88	110	132	700	10	100	10	10	50	1
C8G150	120	150	180	700	10	100	10	10	50	1
C8G230	184	230	276	800	10	100	10	10	100	1
C8G250	200	250	300	800	10	100	10	10	100	1
C8G300	240	300	360	800	10	100	10	10	100	1
C8G350	280	350	420	900	10	100	10	10	100	1
C8G470	376	470	564	1100	10	100	10	10	250	1
C8G600	480	600	720	1300	10	100	10	10	250	1
C8G800	640	800	960	1400	10	100	10	10	500	1
C8G1000	800	1000	1200	1600	10	100	10	10	500	1

CNR - CG series : UL - 497B (Protector for data communication and fire alarm circuit)
E220380 : Section1

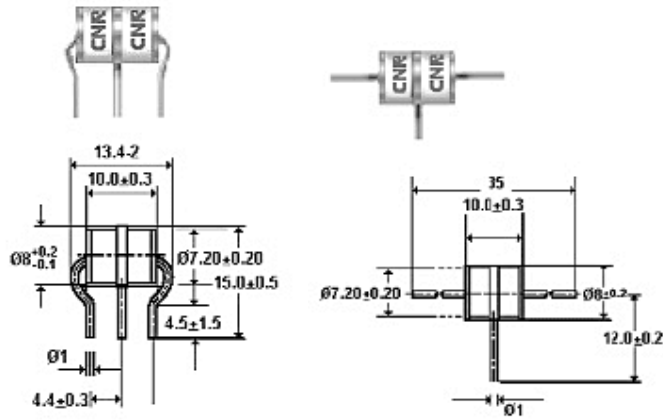
C3LG – SERIES (7.2mm)

CNR	DC SPARK-OVER VOLT			IMPULSE SPARK-OVER	NOM. IMPULSE DISCHARGE CURRENT(S)	NOM. IMPULSE DISCHARGE CURRENT(L)	NOM. DISCHARGE CURRENT	INSULATION RESISTANCE		CAPCITANCE
	Vs(V)			Vis(V)				Ri(Ω)		C(pF)
P/N	100V/sec			1kV/usec	8x20usec	10*1000usec	1sec;50Hz	Min(log)	@	1KHz
	Min	Typical	Max	Max	kA	A	A	ohm	V	Max
C3LG60	48	60	72	600	5	50	5	9	20	2
C3LG75	60	75	90	600	10	100	10	9	25	2
C3LG90	72	90	108	700	10	100	10	9	50	2
C3LG150	120	150	180	700	10	100	10	9	50	2
C3LG230	184	230	276	800	10	100	10	9	100	2
C3LG350	280	350	420	800	10	100	10	9	100	2
C3LG470	376	470	564	900	10	100	10	9	250	2
C3LG600	480	600	720	1200	10	100	10	9	250	2

CNR-CG series: UL-497B (Protector for data communication and fire alarm circuit)
E220380: Section 1

Definitions & Measuring Parameters

Electrical Characteristics

Characteristics	Marks	Descriptions
Normal DC spark-over voltage	Vs	This is a rated value (which is tested under a low rate of rise $dv/dt=100V/sec$) and tolerance of DC spark-over voltage
Impulse spark-over voltage	Vis	This is a rated value (which is tested under a high rate of rise $dv/dt=1000V/usec$) and tolerance of impulse spark-over voltage

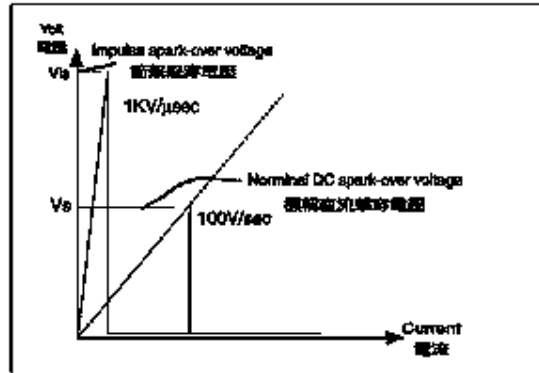

Characteristics	Marks	Descriptions
Normal impulse discharge current(8*20μsec)	8*20μsec	Rated discharge current of 8*20μsec waveform: requirements:10 times
Normal impulse discharge current(10*1000μsec)	10*1000μsec	Rated discharge current of 10*1000μsec waveform:requirements:10times

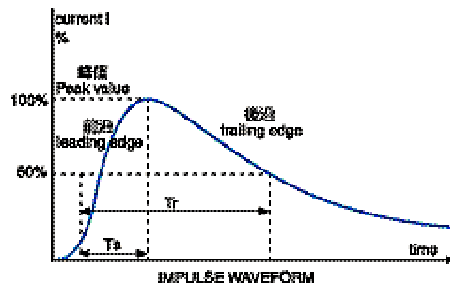

time waveform	Ta(μsec)	Tf(μsec)
8*20μsec	8	20
10*1000μsec	10	1000

Characteristics	Marks	Descriptions
Normal discharge current	1sec;50Hz	Rated discharge ac current under condition as 50Hz/1sec:10 times
Insulation resistance	Ri	Minimum resistance at a non-ignited voltage
Capacitance	C	Self-capacitance of CNR-GDT arresters.